

ELECTRICAL PROPERTIES

Critical Impulse Flashover Voltage		
Positive	kV	135
Impulse Withstand Voltage	kV	110
Wet p.f. Withstand Voltage	kV	45

PHYSICAL PROPERTIES

Nominal Creepage Distance	In.	17.38
Net Weight	lb.	9.9
Color		Light Grey

MECHANICAL PROPERTIES

Cantilever Strength, Upright	lb.	1000
Cantilever Strength, Underhung	lb.	1000
Torsion Strength	in. - lb.	5000
Tension Strength	lb.	5000
Reference Standard		ANSI C29.9

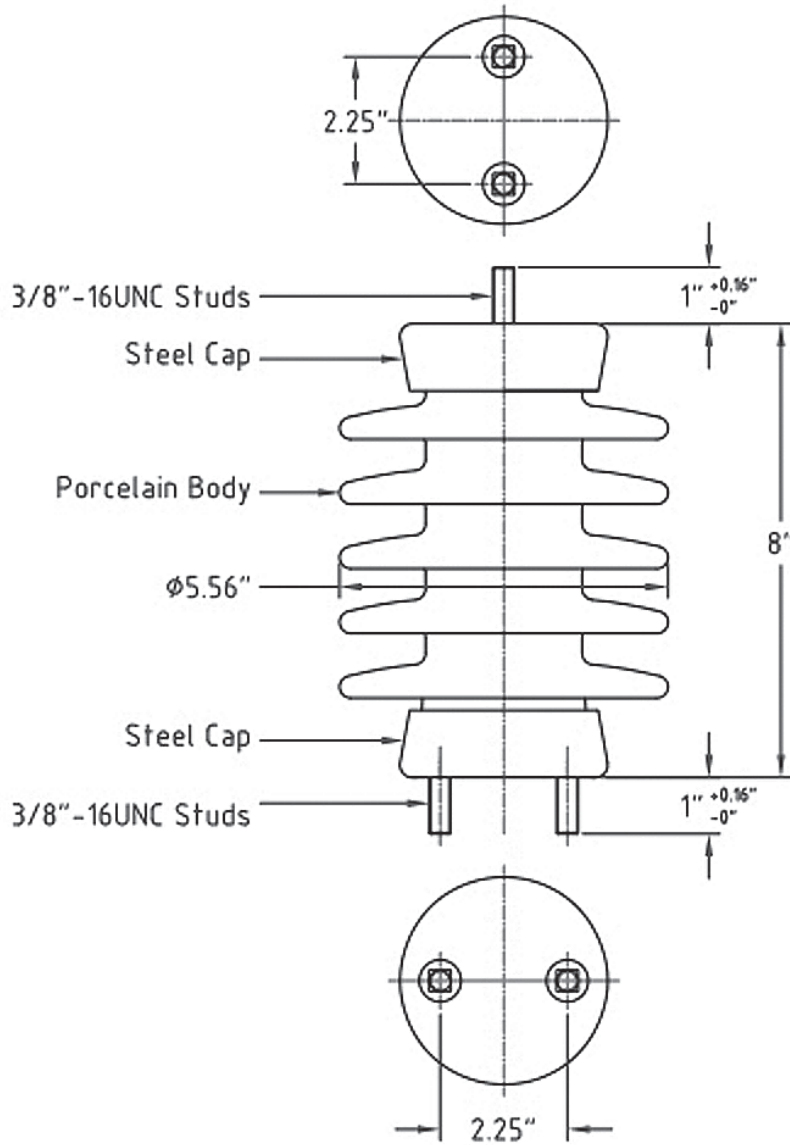

NOTES:

1. All ferrous parts Hot Dip Galvanized.
2. Exposed cement surface coated with silicone.



Medium Voltage Solutions

Erie, Pennsylvania, USA
Tel: 814-520-6385
Email: info@mvpower.us
Web: www.mvpower.us

PART NO. 6036AX
PORCELAIN SWITCH POST INSULATOR
15kV, 110kV BIL